



Frangible Couplings & Floor Flanges

Frangible couplings are designed to break away cleanly upon impact, minimizing damage to an aircraft during an accident. Common applications include support for runway/taxiway lights, heliport flood lights,

and masts. Please review your product manual to ensure you order the correct coupling. To avoid premature or catastrophic failure, frangible couplings should only be used for approved applications.

1" Diameter Risers

Frangible Coupling for Mounting 1" Diameter Riser to 1935 Baseplate (1-1/2" Thread)

For L-860/L-861/L-862 runway/taxiway edge and heliport flood lights.

Part Numbers:	FL-FC1.5-Y: Yellow Powder Coat FL-FC1.5-R: Red Powder Coat FL-FC1.5-MT: Marine Treated
Height:	2.6"
Top Dimensions:	1.62" OD, 1.22" ID
Bottom Dimensions:	1.38" OD, 1.03" ID
Upper Flange Bolt:	1 bolt included: hex head, 1/4-20 x 3/4", stainless steel
Thread:	1" -1/2-12 UNF-2A
Material:	Aluminum

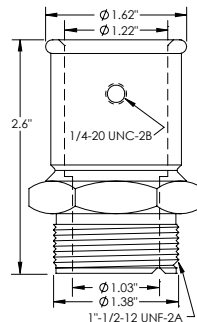

Frangible Reducer Coupling for Mounting 1" Diameter Riser to 1932 Baseplate (2" Thread)

For L-860/L-861/L-862 runway/taxiway edge and heliport flood lights.

Part Numbers:	FL-FC2.0-Y: Yellow Powder Coat FL-FC2.0-R: Red Powder Coat FL-FC2.0-MT: Marine Treated
Height:	2.97"
Top Dimensions:	1.56" OD, 1.19" ID
Bottom Dimensions:	2.31" OD, 1.81" ID
Upper Flange Bolt:	1 bolt included: hex head, 1/4-20 x 3/4", stainless steel
Thread:	2" NPT
Material:	Aluminum

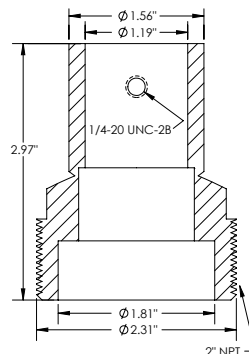

2" Diameter Risers

Frangible Coupling for Mounting 2" Diameter Riser to 1932 Baseplate (2" Thread)

For military fixtures.

Part Numbers:	66-961: Anodized 66-961-Y: Yellow Powder Coat 66-961-O: Orange Powder Coat
Height:	3.69"
Top Dimensions:	2.4" OD, 2.2" ID
Bottom Dimensions:	2.35" OD, 1.85" ID
Thread:	2" -11-1/2 NPSL
Material:	Aluminum

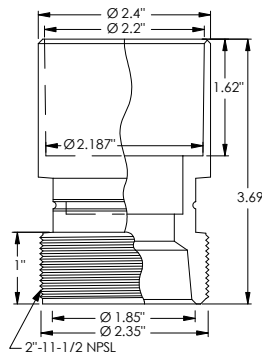



2" Frangible Coupling (Thread Both Ends)

For fencing or approach systems where the control panel mounts on rigid pipe instead of EMT.

Part Number:	66-961B: Anodized
Height:	3.83"
Top Dimensions:	2.35" OD, 1.8" ID
Bottom Dimensions:	2.35" OD, 1.75" ID
Thread:	2" -11-1/2 NPSM both ends
Material:	Aluminum

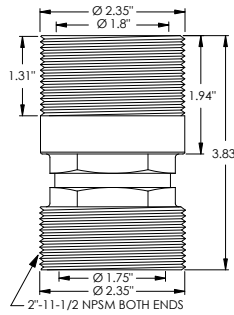

66-961B

Frangible Coupling for 2" NPT EMT

For L-862 runway edge lights and approach lights: PAPI (only used on Airport Lighting Co. PAPIs), REIL, MALSR.

Part Number:	75-59E: Anodized
Height:	5.7"
Top Dimensions:	2.7" OD, 2.2" ID
Bottom Dimensions:	2.35" OD, 1.8" ID
Thread:	2" -11-1/2 NPT
Material:	Aluminum

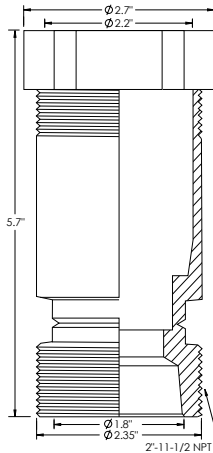

75-59E

D-Lux, I-Lux Sign Couplings

Used for mounting D-Lux, I-Lux taxiway and runway signs.

D-Lux Part Numbers:	32-D6-DC1: Size 1 D-Lux sign 32-D6-DC2: Size 2 D-Lux sign 32-D6-DC3: Size 3 D-Lux sign
Height:	6"
Dimensions:	2.37" OD, 2.07" ID
Thread:	2" NPT
Material:	Aluminum

I-Lux Part Numbers:	32-I6-FC1: Size 1 I-Lux sign 32-I6-FC2: Size 2 I-Lux sign 32-I6-FC3: Size 3 I-Lux sign 32-I6-FC4: Size 4 I-Lux sign
Height:	6"
Dimensions:	2.37" OD, 2.07" ID
Thread:	2" NPT
Material:	Aluminum

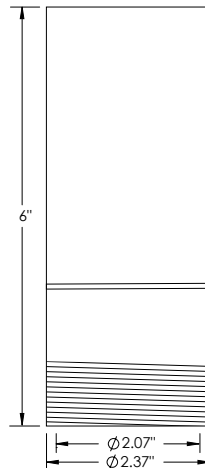

D-Lux: 32-D6-DCx
(x = sign size)

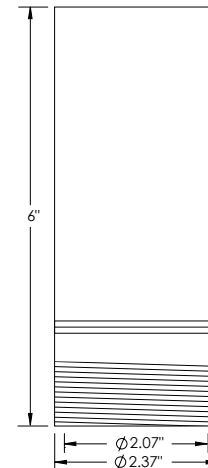

I-Lux: 32-I6-FCx
(x = sign size)

2" Double Compression Type EMT Coupling

Used to join Electrical Metallic Tubing (EMT) to a box or to couple two ends of EMT conduit.

Part Number:	77-REG616
Height:	3"
Dimensions:	2.74" OD, 2.18" ID
Material:	Zinc Die-Cast

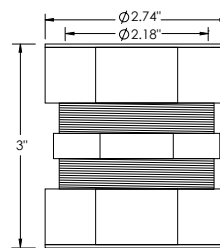

77-REG616



PAPI Frangible Floor Flange

Used for mounting Flight Light Inc. PAPI light housing assemblies. Designed to receive 2" Electrical Metallic Tubing (EMT).

Part Number:	15-FFF2X425
Height:	2.94"
Top Dimensions:	2.58" OD, 2.19" ID
Bottom Dimensions:	4.12" x 4.12"
Bolt Circle:	4.25"
Upper Flange Bolts:	3 bolts included: hex head, 1/4-20 x 1.0", stainless steel
Bottom Flange Bolts:	4 bolts not included: flat head, 3/8-16 x required depth
Material:	Aluminum

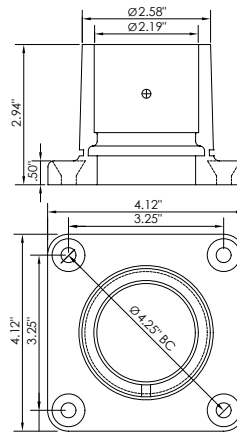

15-FFF2X425

6" Rigid Floor Flange (2" Thread)

Used for mounting wind cones, obstruction lights, approach lights and helipad elevated lights.

Part Numbers:	HA-B1A0009SDE2: Anodized HA-B1A0009SDE3: Orange HA-B1A0009SDE5: Yellow HA-B1A0009SDE6: Marine Treated HA-B1A0009SDE7: Red
Height:	1.25"
Top Dimensions:	3" OD, 2.26" ID
Bottom Dimensions:	6" OD
Bolt Circle:	4.75"
Bottom Flange Bolts:	4 bolts not included: flat head, 1/2 or 3/8-16 x required depth.
Thread:	2" NPS
Material:	Aluminum



HA-B1A0009SDE2
Anodized



HA-B1A0009SDE3
Orange



HA-B1A0009SDE5
Yellow



HA-B1A0009SDE6
Marine Treated

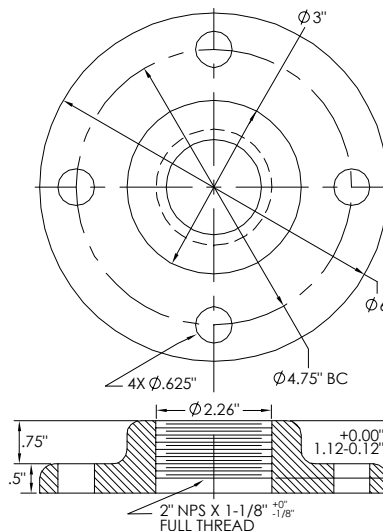

HA-B1A0009SDE7
Red