



Flight Light Inc.
 2708 47th Ave.
 Sacramento, California, U.S.A.
 95822-3806
 www.flightlight.com
 sales@flightlight.com

+1.800.806.3548
 +1.916.394.2800

atg airports (formerly ALSTOM)
ZA202 Omnidirectional Semiflush
Taxiway and Runway Inset Edge Light

Compliance and Applications

US Air Force AFR 88-1
 ICAO Annex 14
 NATO STANAG 3316
 US Navy NAVAIR 51-50AAA-2
 FAA: Our ZA202 was specifically designed as a medium intensity taxiway and/or runway semiflush edge light. However, the FAA has no specification governing this application. This fixture performs better in these applications and is generally preferred to the frequently misapplied L852E specification, which is only applicable to taxiway centerline intersections (115W, yellow).

Why Our ZA202 is Better

- ✓ Meets L861 requirements with 45W lamp.
- ✓ Meets load test for L852 FAA AC 150/5345-46A, NATO Stanag 3316, ICAO Annex 14.
- ✓ L867, L868 or 8" mounting configuration.
- ✓ Decades of proven use.
- ✓ Reduced maintenance costs through use of off-the-shelf lamps and lamps that can be changed in the field.
- ✓ Pressure test plug for photometric chamber allows verification of moisture tight seal. This reduces maintenance costs by avoiding premature lamp outage and increases photometric performance by eliminating moisture clouding on the lens.
- ✓ Corrosion resistant powder coated finish.
- ✓ 6.6A fixture shipped with L823 plug lead.

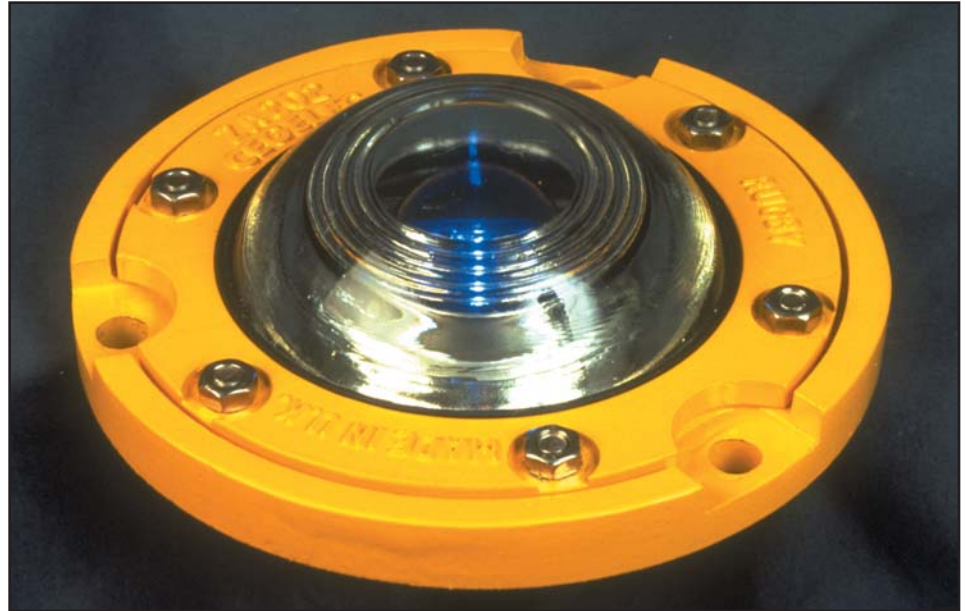

Airport Applications

Used to replace elevated medium intensity taxiway and runway edge lights at locations where the lights are frequently knocked down by aircraft or maintenance vehicles. Taxiway or low intensity runway edge lights use 6.6A lamps.

Please visit our website for more information
www.flightlight.com

Ordering Code

Fixture	Body Style	Color	Lamp	Mounting
ZA202	6: 6.6A Low profile	B: Blue G: Green R: Red W: White Y: Yellow	45: 45W, 6.6A	A: L868 Size B, 11.25" bolt circle* B: L867 Size B, 10.25" bolt circle** C: 8" diameter x 10" deep base
ZA202				

* For mounting on L868B base order 16-28905 adapter ring, sold separately.

** For mounting on L867B base order 30-867A812 adapter ring, sold separately.

Visit our web site: www.flightlight.com



Flight Light Inc.
 2708 47th Ave.
 Sacramento, California, U.S.A.
 95822-3806

+1.800.806.3548
 +1.916.394.2800

www.flightlight.com
 sales@flightlight.com

atg airports (formerly ALSTOM)
ZA202 Omnidirectional Semiflush
Taxiway and Runway Inset Edge Light

ZA202 Photometric Performance

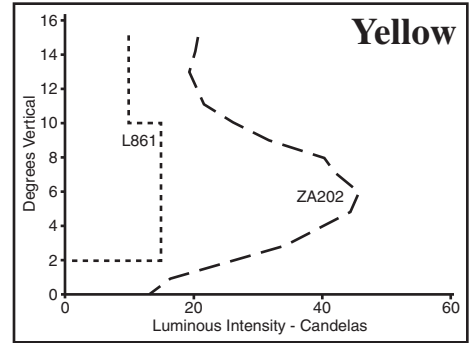
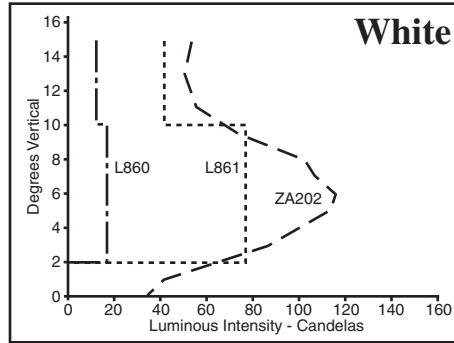
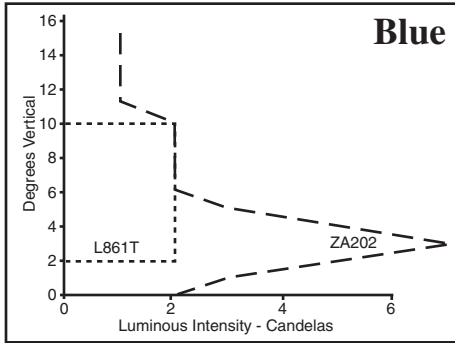

Mounting Configurations

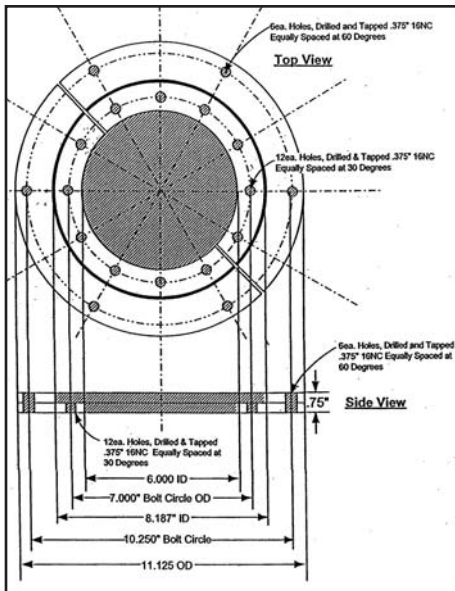

L-867B Adapter/Flange Ring
 (2 piece for mounting under can flange)
 P/N 30-867A8-12-2

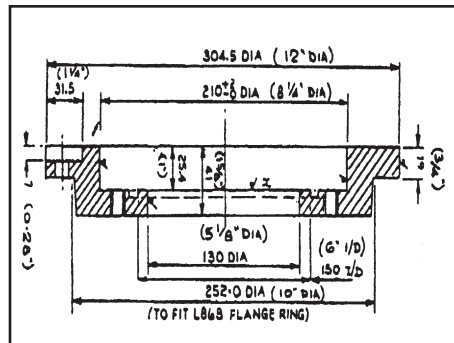

L-868B Adapter/Flange Ring
 P/N 16-28905

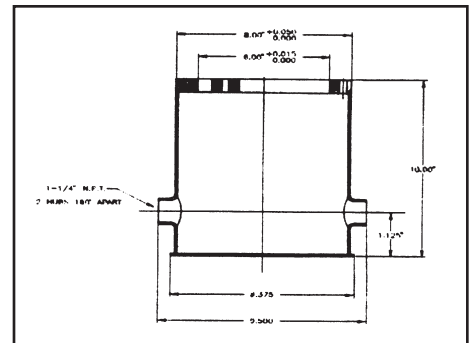

L-868 Size AA (8" dia. x 10" deep, or deeper as required)
 P/N 35-868AA-XX (XX=inches)

Sample Fixture Configuration

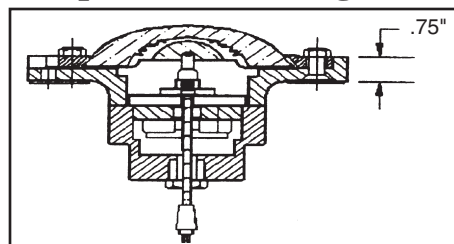

Taxiway edge light, 6.6A. Replaces elevated taxiway edge lights.

Common Replacement Parts

80-016015	Glass dome
80-25990	Pressure test plug
80-033014	Dome gasket
80-021189	Dome retaining ring-yellow
80-021273	Dome retaining ring-black
80-019092	Yellow filter, 6.6A
80-019118	Blue filter, 6.6A
80-019013	Green filter, 6.6A
80-028551	Seating gasket for ZA202/29

Visit our web site: www.flightlight.com